

*LAST
RESORT
CLINIC
IP*

Grace Sweeney

*What is
patentable?*



What is patentable?

Statutory subject matter

- Machine
 - Articles of manufacture
 - Composition of matter
 - Process ("method")
-
- 

What is patentable?

1. Machine



What is patentable?

1. Machine

Jan. 12, 2014

JEREMY BAILEY
APPARATUS FOR THE ELECTRONIC CONSUMPTION OF NICOTINE FROM A DOLPHIN-SHAPED FLUTE SYNTHESIZER, BUBBLE MACHINE, MULTIMEDIA PROJECTOR

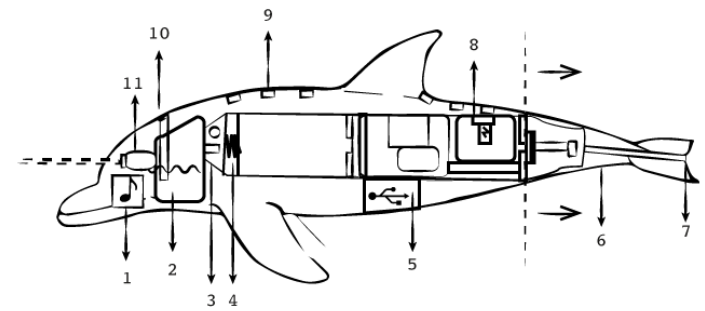

FIG. 1

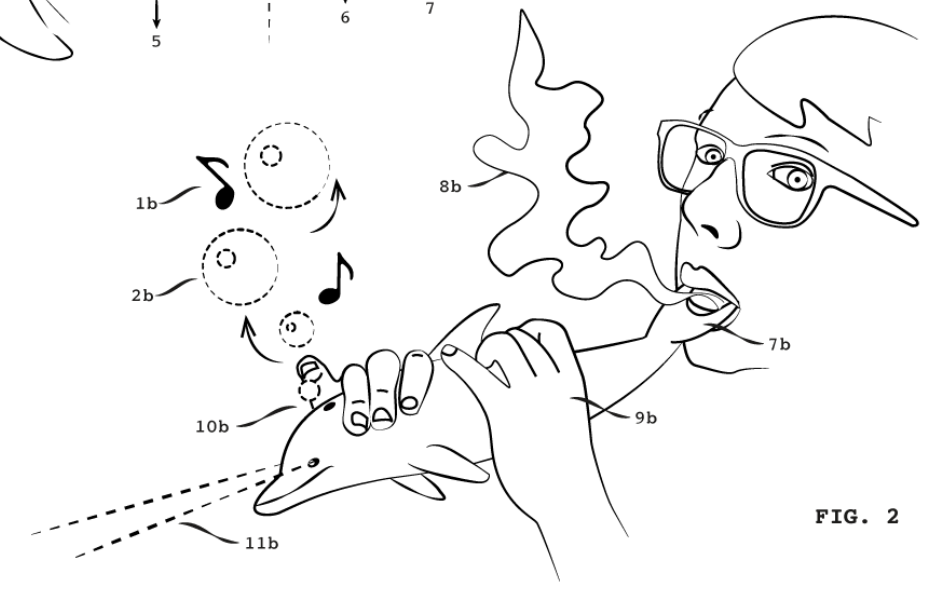



FIG. 2

What is patentable?

2. Article of manufacture



What is patentable?

2. Article of manufacture

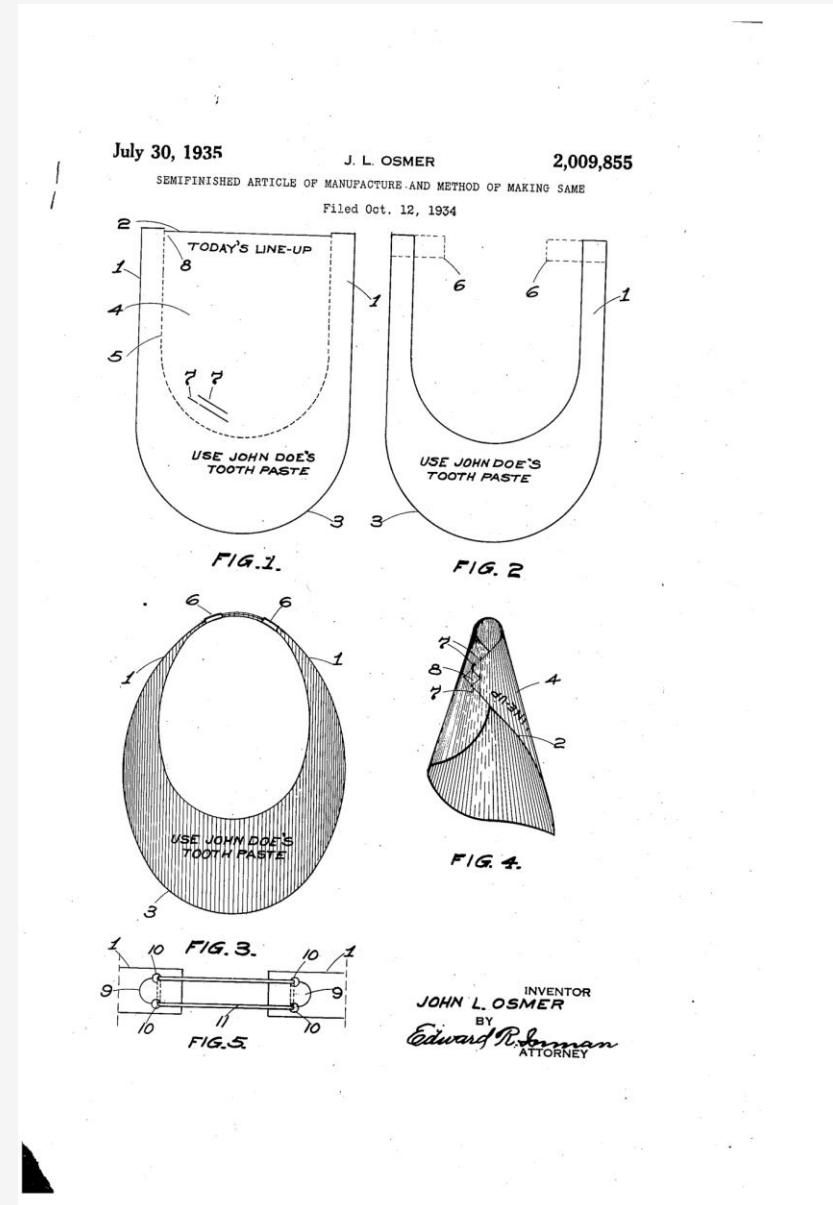

What is patentable?

3. Composition of matter



What is patentable?

3. Composition of matter

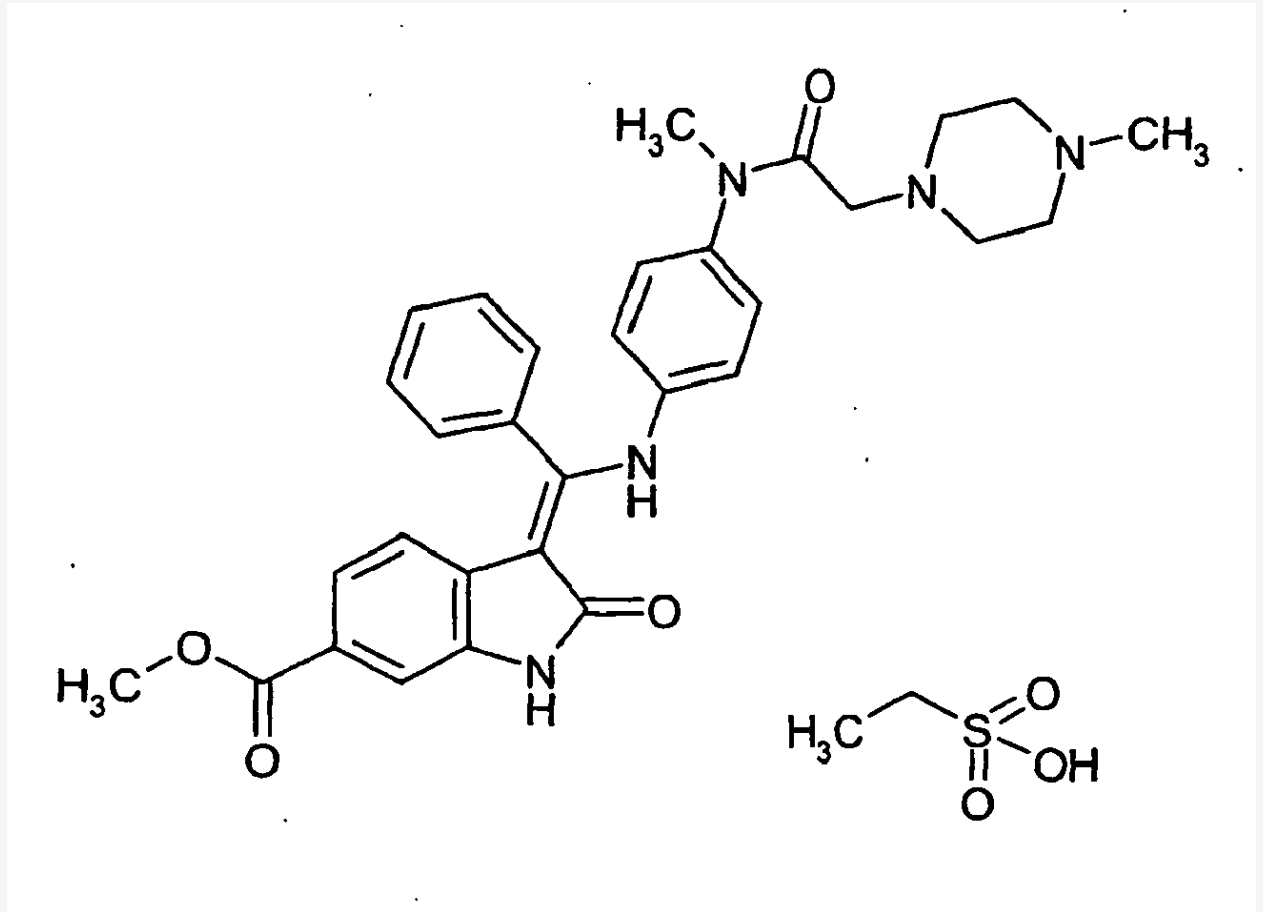

What is patentable?

4. Process ("method of use")



What is patentable?

4. Process ("method of use")

FIGURE 2

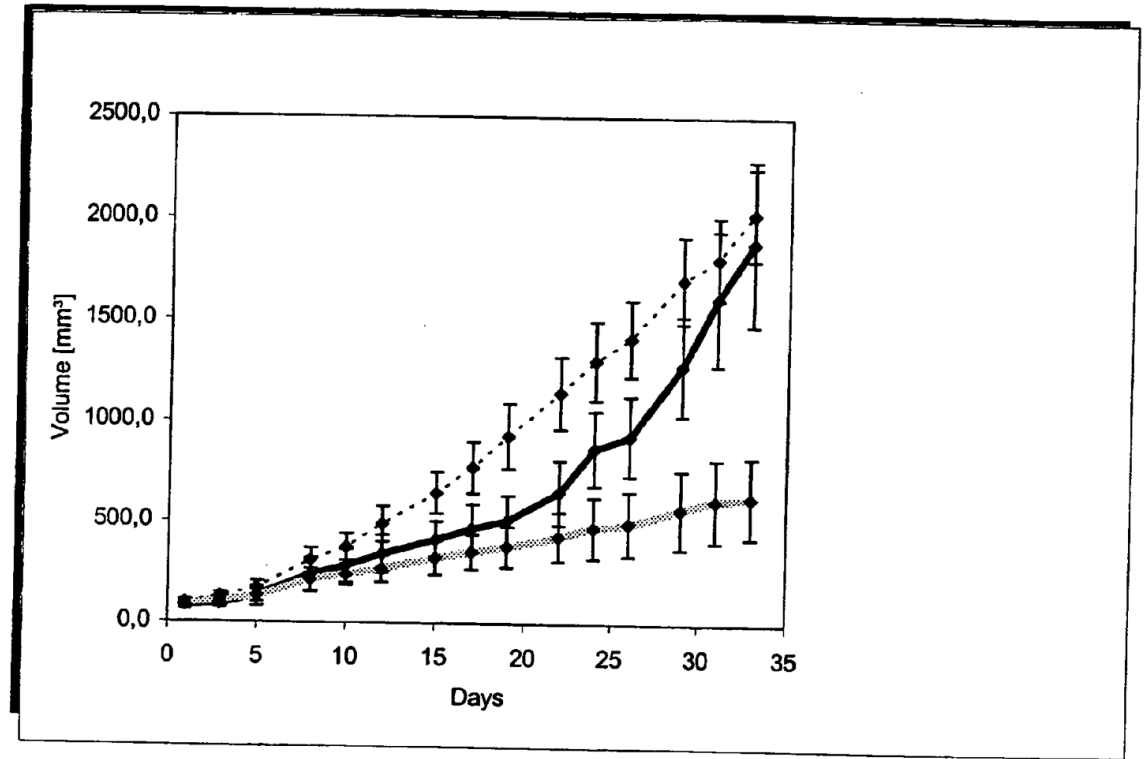

What is patentable?

Improvements are patentable

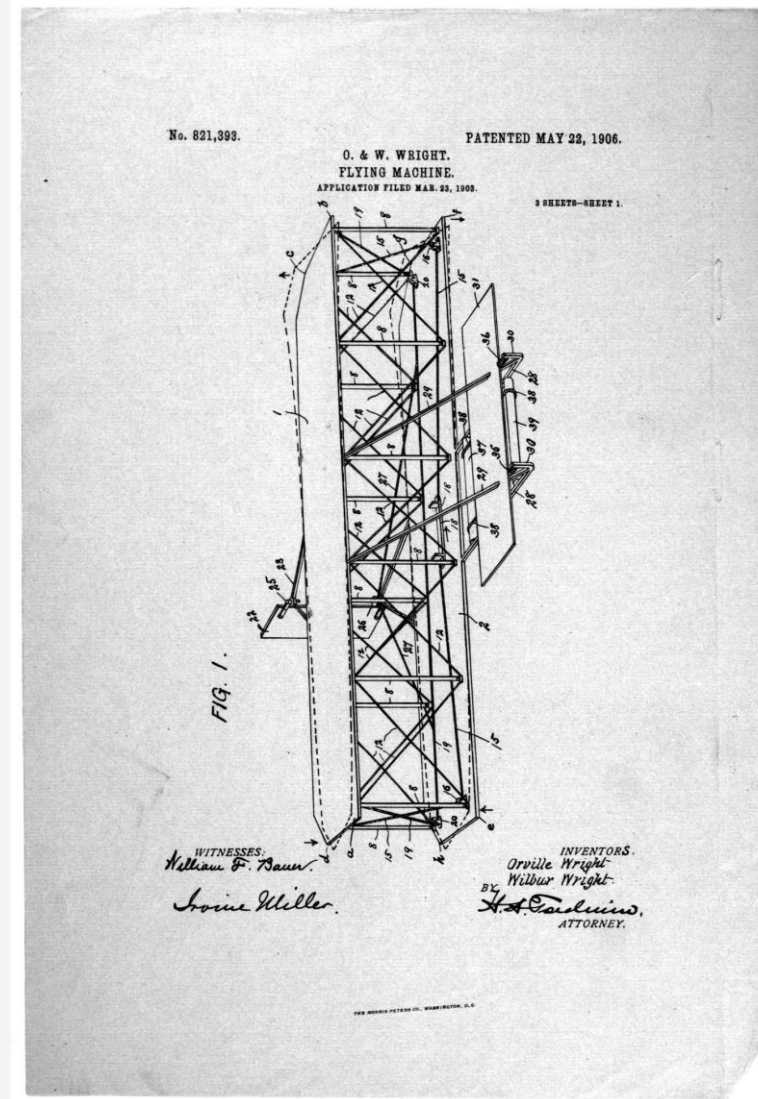

What is not patentable?

Non-Statutory Subject Matter:

- arrangement of houses or a plot of land
 - becoming rich
 - colouring substances for identification
 - musical notation
-
- 

What is not patentable?

Prohibited Subject Matter:

- Abstract idea
 - Law of nature
 - Natural phenomenon
-
- 

*How do we
patent
LaRC
discoveries?*



*How do we
patent
LaRC
discoveries?*

- New
 - Useful
 - Non-obvious
- 

*How do we
patent
LaRC
discoveries?*

1. Novelty



Claims

We claim:

1. A method for making a humanized antibody comprising non-human, import Complementarity Determining Region (CDR) amino acid residues and human Framework Region (FR) amino acid residues, comprising the steps of:
 - (a) obtaining the amino acid sequences of an import variable domain and of a V.sub.H subgroup III consensus human variable domain;
 - (b) identifying CDR amino acid sequences in the import and the human variable domain sequences;
 - (c) substituting import CDRs for the corresponding human CDRs;
 - (d) aligning the amino acid sequences of a FR of the import antibody and the corresponding FR of the consensus variable domain;
 - (e) identifying import antibody FR residues in the aligned FR sequences that are non-homologous to the corresponding consensus variable domain residues;

*How do we
patent
LaRC
discoveries?*

2. Utility

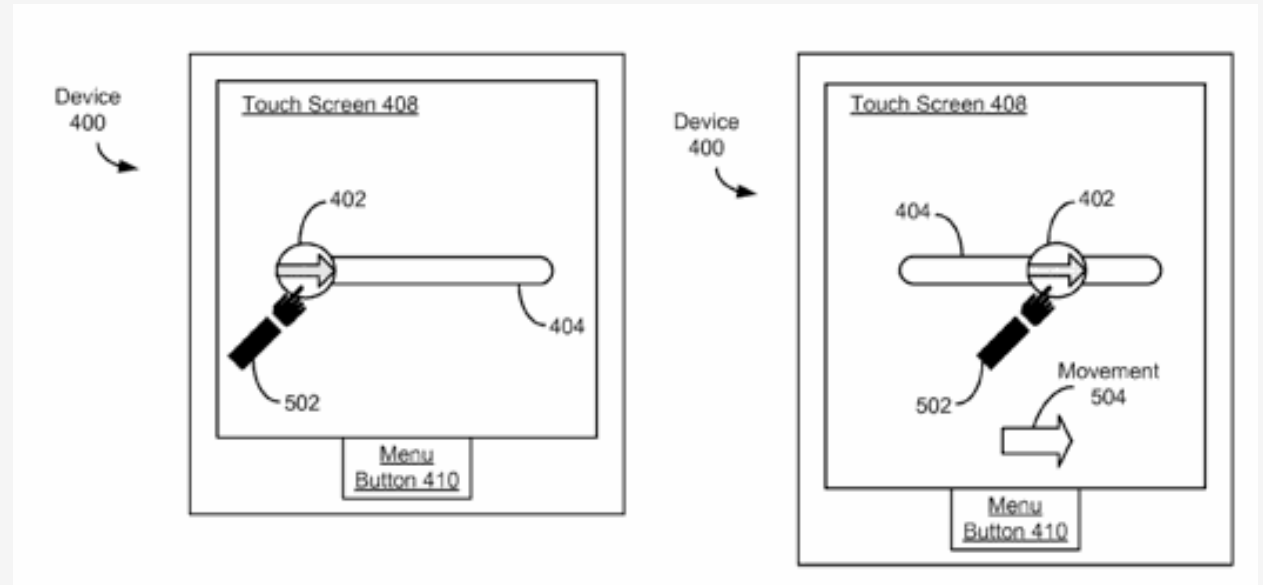

*How do we
patent
LaRC
discoveries?*

3. Non-obvious

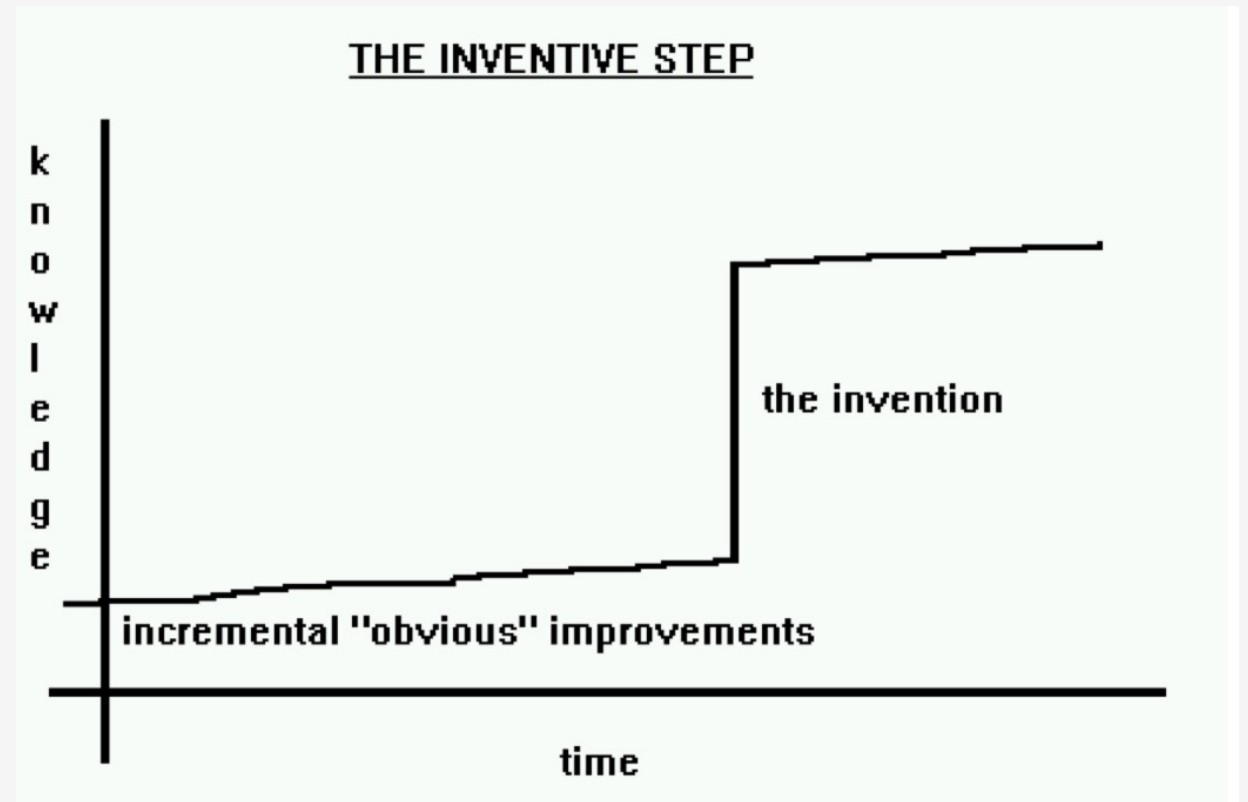

*How do we
patent
LaRC
discoveries?*

Combinations, not aggregations



*How do we
patent
LaRC
discoveries?*

Additional Strategies to Bolster IP:

- Orphan drug designation
 - Paediatric exclusivity
 - Shelved drugs offer inherent exclusivity
 - Additional trademark protection
 - Establish a patent estate
- 